

LUMINO

V12S IP67

INSTALLATION MANUAL

IMV12S_IP67_R2102

TECHNICAL SUPPORT
+44(0) 1279 635 411
www.lumino.lighting

LUMINO DISTRIBUTION LTD
Lumino House, Lovet Road
Harlow, Essex CM19 5TB
United Kingdom

Installers must read this document and any other referenced documents in full before commencing installation work. Failure to observe all installation guidance in this document may result in unsafe installation, cause permanent product damage and void product warranty.

This document is subject to change without notice.
Check for latest documentation with LUMINO.
Copyright © LUMINO. E&OE



HANDLING PRECAUTIONS

PLASTIC COVER / DIFFUSER

To avoid permanent damage, do not allow small or sharp objects to apply pressure on to the plastic cover / diffuser.

STRESS

Never stand or place weighted items on the product. The product is not vandal resistant and has no IK rating. Do not subject the product to impact forces.

POWER CABLES

The product end caps, power cables and connectors must not be pulled or twisted. Never pull the product by its power cables or hang it from its power cables or connectors.

CUTTING AND SAWING

The product must not be sawn, drilled or otherwise modified in any way.

DAMAGES

Inspect the product. If you see any damage upon unpacking, report to LUMINO immediately and do not install the product.

LOCATION

Suitable for wet locations. IP67 rated for temporary submersion for no more than 30mins. Ensure there is adequate drainage made available for the product.

Protect product from dust, paint and harmful substances during installation and use. Ensure product is not exposed to VOC gases. Do not obstruct the product and its light output.

SAFETY GUIDANCE

WIRING GUIDE

Follow the guidance shown in the provided wiring guide, including maximum cable lengths, cable sizes and other wiring instructions. When running cables through an enclosure, ensure cables are protected from damage, separated from mains voltage cables and anchored against being pulled. Make connections appropriate for the IP rating of the product.

QUALIFIED INSTALLER

Installation must be carried out by a qualified person and conducted in accordance with local regulations and applicable standards.

THERMAL MANAGEMENT

Ensure ambient temperature (T_a) does not exceed 40°C (104°F) and case temperature (T_c) does not exceed 70°C (158°F). Exceeding maximum T_c will cause permanent damage and void the product warranty.

Allow sufficient clear air space for the LED drivers, as well as suitable access to the drivers as specified on installation instructions.

REPAIR AND REPLACEMENT

If the product is not functioning, contact LUMINO to register a Service Call for factory repair or replacement. Light source is not user replaceable. See page 3 for Ecodesign and end of life information.

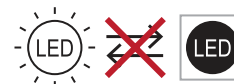

DRIVERS

POWER OFF

Product and driver must not be live wired. Switch off power before work begins. Follow instructions and guidance for the make and model of driver being used.

24VDC SELV

Only use drivers with a maximum output of 24VDC. Drivers must be SELV, constant voltage with both overload and short-circuit protection.

DIMMERS

Check dimmer is compatible with the driver and certified to local regulations.

INRUSH CURRENT

Many constant voltage LED drivers can have high inrush current at power-on. Driver's inrush current can be many times the normal operating current. Use a suitable MCB. Type C MCBs are normally suitable but if inrush current is a persistent problem an inrush suppressor may be required.

PROTECTION

Use only with 24VDC Class 2 power unit to UL1310 standard with overload and short-circuit protection. Rate drivers for at least 10% above load. Driver protection circuitry must not be relied upon to protect secondary 24VDC electrical circuits from damage caused by over-current or short circuit. DC fuses or DC electronic circuit breakers are recommended for full protection. Allow for access to drivers for maintenance and sufficient clear air space for ventilation.

CABLING

Do not overload the driver. Damage will be caused by incorrect input voltage, reverse polarity or short circuit. Plan for loads, driver locations, dimming and cabling prior to start of work. Ensure basic insulation is maintained between mains and dimming control wires.

ACCESSORIES

Cable & Connector

VECA-CA0250-___MF-R1
2 / 4 Pole power link
250mm cable length

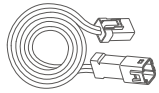

VECA-CA1000-___MF-R1
2 / 4 Pole power link
1000mm cable length

IDC Connector

VECA-CA90_-R1
Sealant connector.
Pair 3A Max / 5A Max.



Self-closing Cable Sleeving

VECA-SL001-R1
1000mm Cable sleeving



Fixed Mount

V12S-MA___-R1
20/100/500pcs Fixed clip
S - Silver / B - Black
W - White

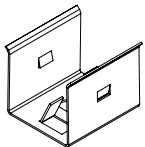

Rotation Mount

V12S-MA___-R1
20/100/500pcs Rotation clip
S - Silver / B - Black
W - White

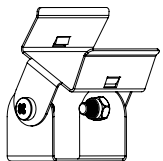

CHECK FIRST!

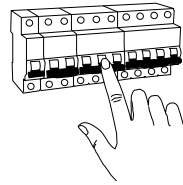

TURN OFF POWER!
COUPER LE COURANT!
STROM ABSHALTEN!
CORTE CORRIENTE!

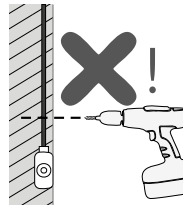

CHECK THE WALL!
VÉRIFIER LE MUR!
DIE WAND ÜBERPRÜFEN!
COMPRUEBE LA PARED!

INSTALLATION

1. Plan Installation

Check product and its dimensions against the planned installation. Runs of LEDs may have to be installed in a particular sequence.

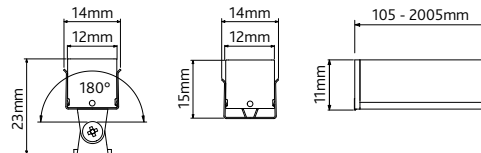

~214g per metre

2. Prepare Power Supply

This product requires a 24VDC power supply.

Please refer to provided wiring guide document. Failure to follow guide may result in damage to the product and voiding of warranty.

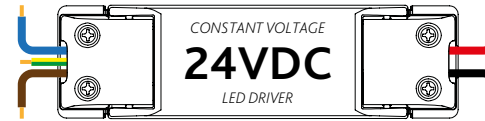

3. Mounting Clips

Fix all the clips securely to the mounting surface. Recommended screw size is a N° 4 gauge wood screw. If necessary, use alternative fixings of a similar gauge and size suitable for the material being fixed into.

Products should be held by at least 3 equally spaced clips per metre. Products shorter than 505mm may be held by just 2 clips. There must always be a clip within 100mm of each end of the product.

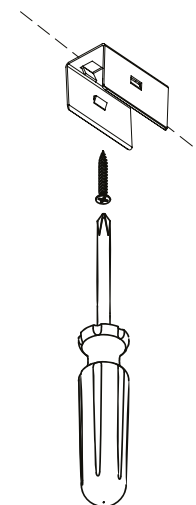

4. Install V12S

Align clips and carefully push the product into the clips. Ensure the product is fully clipped in place and check it is not misaligned or misplaced due to screw heads or wires. Ensure that cables are not pinched when installed.

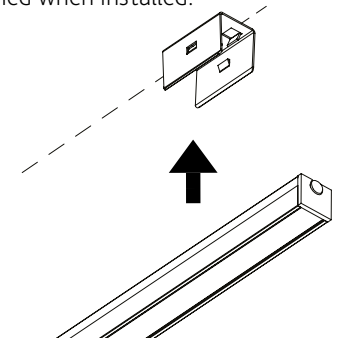

5. Connect to LED Driver

With the power off. Feed power cables to the V12S, connecting the product to the LED driver.

Finalise all electrical connections and test the circuit. If the product does not function as expected, turn power off immediately and check all connections.

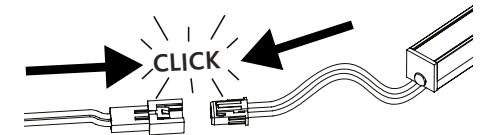

5. Protect exposed cable

Self-closing cable sleeving: VECA-SL001-R1

For outdoor applications, the power cable must be wrapped in cable sleeving to protect the cable from UV exposure. Trim sleeving to match cable length.

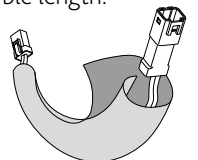

LUMINO

ECODESIGN REGULATION

This product is considered to be a “containing product” in the sense of Regulations (EU) 2019/2020 and (EU) 2019/2015.

The contained light source is an integrated part of the containing product and its removal can only be done by causing permanent damage to the containing product.

Therefore, replacement of the light source with the use of commonly available tools is not justified due to its restricted mechanical, electrical, optical, thermal and/or environmental protection requirements.

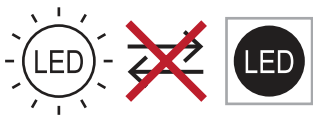

DISMANTLING

Dismantling of light source from the containing product at end of life:

The containing product shall be cut to the length of the contained light source and the light source mechanically detached from the containing product. Containing product component parts shall then be disassembled.

Containing products shall be separated from building material and/or from other additional mounting accessories by means of a professional installer.

Separate control gear and light sources must be disposed of at certified disposal companies in accordance with Directive 2012/19/EU (WEEE) in the EU and with Waste Electrical and Electronic Equipment (WEEE) Regulations 2013 in the UK.

LUMINO is a member of the WEEE producer compliance scheme.
Registration number: WEE/MM8138AA

ENERGY RATING

This product contains light sources of energy efficiency classes as shown:

LED	CCT	6W/m	12W/m
ColorCORE	4000K	F	F
	3500K	F	F
	3000K	F	F
	2700K	F	F
	2500K	F	F
	2200K	F	F
EQ	4000K	F	F
	3000K	G	G
	2700K	G	G
RGB	N/A		