

LUMINO

MATCH 5 M5-SL

INSTALLATION MANUAL

IMNA-M5-SL_R2301

TECHNICAL SUPPORT

+1 305 413 5051
www.lumino.lighting

LUMINO North America Inc
66 W Flagler Street, STE 900
Miami, FL 33141
USA



Installers must read this document and any other referenced documents in full before commencing installation work.

Failure to observe all installation guidance in this document may result in unsafe installation, cause permanent product damage and void product warranty.

This document is subject to change without notice. Check for latest documentation with LUMINO. Copyright © LUMINO. E&OE

HANDLING PRECAUTIONS

OPTIC / LENS

To avoid permanent damage, do not allow small or sharp objects to apply pressure on to the plastic optic/lens.

STRESS

Never stand or place weighted items on the fixture. The fixture is not vandal resistant and has no IK rating. Do not subject the fixture to impact forces.

FIXING SURFACES

Check that surface is appropriate for the fixture being installed and can support its weight.

MODIFYING

The fixture must not be sawn, drilled or otherwise modified in any way.

DAMAGES

Inspect the product and accessories. If you see any damage upon unpacking, report to LUMINO immediately and do not install the product.

LOCATION

Check product label or specification for suitability for dry, damp or wet locations.

Protect fixture from dust, paint and harmful substances during installation and use. Ensure fixture is not exposed to VOC gases. Do not obstruct the product and its light output.

SAFETY GUIDANCE

WIRING GUIDE

When running cables through an enclosure, ensure cables are protected from damage. Make connections appropriate for the location rating of the product.

QUALIFIED INSTALLER & PRECAUTIONS

Installation must be carried out by a qualified person and conducted in accordance with local codes and national standards. Use appropriate PPE and tools for the installation, as well as have a sufficient number of qualified personnel to carry out the work.

THERMAL MANAGEMENT

Ensure ambient temperature (Ta) does not exceed 95°F and case temperature (Tc) does not exceed 185°F. Exceeding maximum Tc will cause permanent damage and void the product warranty.

Allow sufficient clear air space for the LED drivers, as well as suitable access to the drivers as specified on installation instructions.

REPAIR AND REPLACEMENT

If defective, contact LUMINO to register a Service Call for factory repair or replacement.

DRIVERS

POWER OFF

Before work commences, ensure the power supply is off. Fixture and driver must not be live wired.

CONSTANT CURRENT DC

Ensure supply current does not exceed 850mA (IC option) or 1050mA (NC option), see product label. Only use this fixture with the supplied LED driver from LUMINO.

DIMMERS

Check dimmer is compatible with the driver and certified to local codes and national standards.

INRUSH CURRENT

Inrush current can reach up to 30A at 120VAC, use a suitable circuit breaker. If inrush current is a persistent problem, an inrush suppressor may be required.

MAINTENANCE

Allow for access to drivers for maintenance and have sufficient clear air space for ventilation.

CABLING

Do not overload the driver. Damage will be caused by incorrect input voltage, reverse polarity or short circuit. Plan for loads, driver locations, dimming and cabling prior to start of work. Ensure basic insulation is maintained between mains and dimming control wires.

ACCESSORIES

Integral LED Driver

-ELV
ELV/TRIAC
Phase Cutting 3%

-D10
0/1-10V
Dim to off 0.1%

-DAL
DALI-2
Dim to off 0.1%

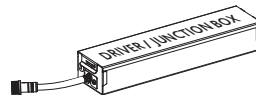

Remote LED Driver

-L01
Lutron Hi-Lume
2-wire, Dim to off 1%

-E01
eldoLED SOLOdrive
Dim to off 0.1% (logarithmic)

-T01
Tunable white driver

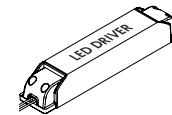

OPTIC FILTERS

-SF
Frosted soft focus filter

-HL
Honeycomb louvre

-SO
Solite Lens

-LS
Linear Spread Lens



INSTALLATION

1. Plan Installation

Fixture must be supplied with either an IC box or non-IC frame, refer to specification. Check this, the fixture and its dimensions against the planned installation.

The IC-box or non-IC frame must be installed beforehand. Considerations should be made about installations in damp or wet environments.

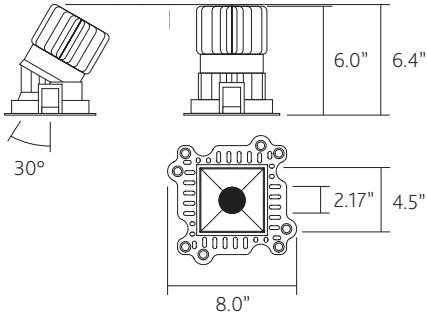

2. Surface Thickness & Space Requirements

It is important to allow plenty of space for the LED engine to effectively cool itself. Void space limits MUST be observed.

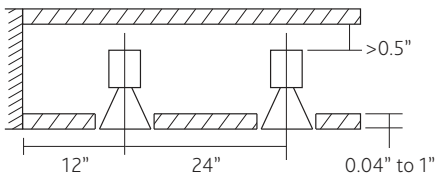

Ceiling Void / MIN Dimensions

3. Drywall Requirements

Ensure that the fixing surface can safely support the weight of the fixture being installed. Make sure that the ceiling cut-out matches what is specified below.

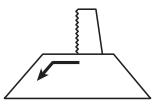

Ceiling Cut-out
5.1 x 5.1"

4. Install Trim

Fix the trim in place using an appropriate adhesive or countersunk screws (min 4 fixings) to securely attach to the drywall.

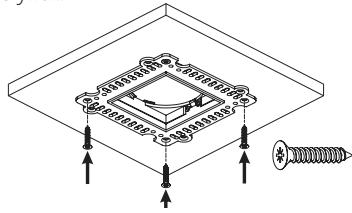

5. Mudding

Mud drywall and trim together. Clean away any excess that gets on to the raised lip of the trim while still wet.

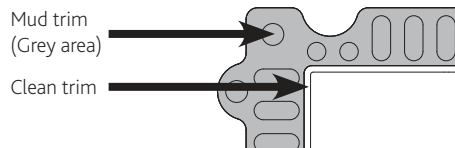
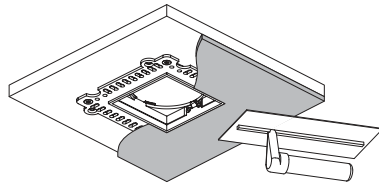

6. Painting

Paint prior to installation of fixture into the ceiling.

7. Connect to Junction Box

With the power off, join and secure the two plugs from the fixture and the junction box together.

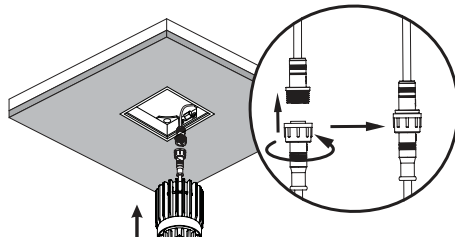

8. Install Fixture

Feed the power cable into the ceiling void, then install the fixture into the ceiling trim. The fixture will click into place and will look flush with the trim.

CHECK! The fixture should not sit proud of the trim. If it does, remove, check for any obstructions and reinstall.

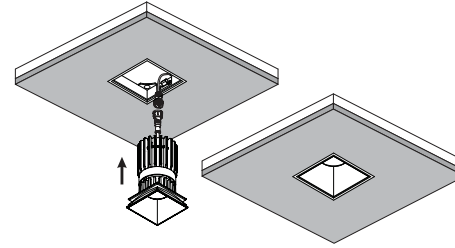

9. Adjustable / Wall Wash / Spreader Lens Option

Adjust the fixture according to the planned installation.

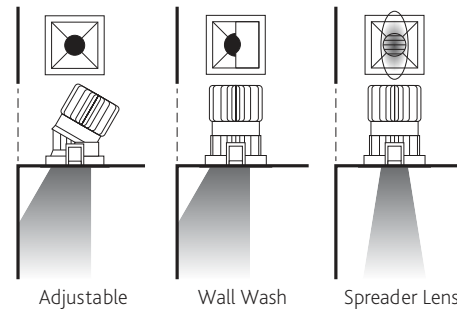

10. Power On / Test

Validate functionality by powering on the fixture. If the fixture does not turn on, turn off the power immediately and check all connections before retesting.

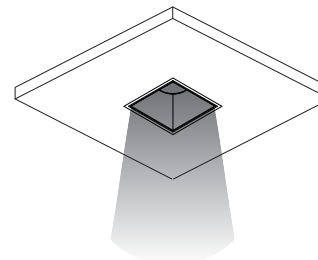

LED DRIVER ACCESS AND REMOVAL

With the power turned off, remove fixture from the trim and disconnect from LED driver. Do not allow the fixture to hang by its cable.

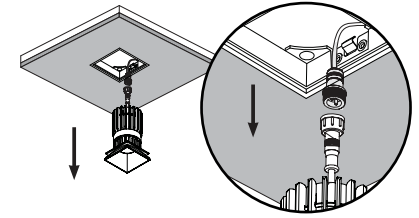

IC - IC Box Option

LED driver is mounted to a gear tray and can be unclipped from the junction box, then fed through the cut-out.

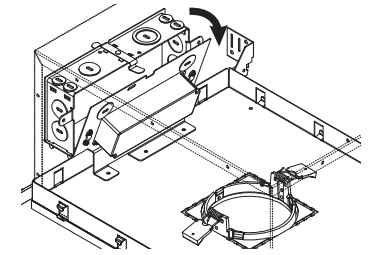

NC - Non-IC Frame Option

Ensure access and removal of the LED driver/junction box is possible, this may either be from below or from above, complying with local codes and national standards.

NC1. Remove Screws

LED driver/junction box is attached to the non-IC frame with screws. Open the junction box and undo the Phillips screws holding the box in place.

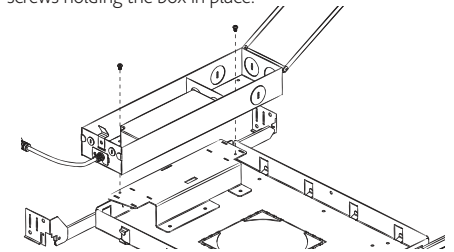

NC2. Removal

Once the screws have been removed, the junction box can be fed through the cut-out.