

LUMINO

M4-NC

INSTALLATION MANUAL

IMNA-M4-NC_R2301

TECHNICAL SUPPORT

+1 305 413 5051
www.lumino.lighting

LUMINO North America Inc
66 W Flagler Street, STE 900
Miami, FL 33141
USA



Installers must read this document and any other referenced documents in full before commencing installation work. Failure to observe all installation guidance in this document may result in unsafe installation, cause permanent product damage and void product warranty.

This document is subject to change without notice.
Check for latest documentation with LUMINO.
Copyright © LUMINO. E&OE

IMPORTANT

QUALIFIED INSTALLER & PRECAUTIONS

Installation must be carried out by a qualified person and conducted in accordance with local codes and national standards. Use appropriate PPE and tools for the installation, as well as have a sufficient number of qualified personnel to carry out the work.

POWER OFF

Before work commences, ensure the power supply is off. Fixture and driver must not be live wired.

FIXING SURFACES

Check that surface is appropriate for fixings or holes to be made prior to commencing work.

DAMAGES, REPAIR AND REPLACEMENT

Inspect the product. If you see any damage upon unpacking, contact LUMINO to register a Service Call for factory a repair or replacement, do not install product.

CUTTING, SAWING, MODIFICATION

Unless specified, the product must not be sawn, drilled or otherwise modified in any way.

INRUSH CURRENT

Inrush current can reach up to 30A at 120VAC, use a suitable circuit breaker. If inrush current is a persistent problem, an inrush suppressor may be required.

DIMMERS

Check dimmer is compatible with the driver and certified to local codes and national standards.

WIRING GUIDE

When running cables through an enclosure, ensure cables are protected from damage. Make connections appropriate for the location rating of the product.

CABLING

Do not overload the driver. Damage will be caused by incorrect input voltage, reverse polarity or short circuit. Plan for loads, driver locations, dimming and cabling prior to start of work. Ensure basic insulation is maintained between mains and dimming control wires.

INSTALLATION

1. Plan Installation

Check product and its dimensions against the planned installation.

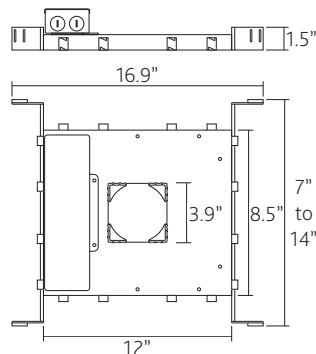

Ensure access and removal of the LED driver/junction box is possible, this may either be from below or from above, complying with local codes and national standards.

2. Surface Thickness & Space Requirements

It is important to allow plenty of space for the LED fixture to effectively cool itself and a surface thickness appropriate for the fixture. Void space limits **MUST** be observed.

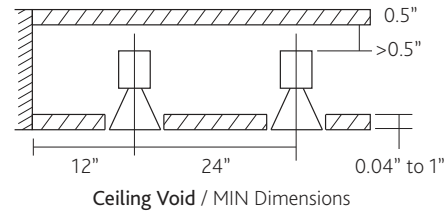

3. Cut-outs

Center cut-outs must match the shape of the product being installed. If the product has a square bezel, remove the four internal corners using pilers or side cutters.

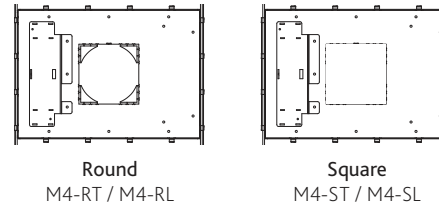

4. Attach Hanger Bars

Attach hanger bars to the non-IC frame. **TAKE CARE** when handling sheet metal parts and not force parts together if there is excessive resistance when assembling.

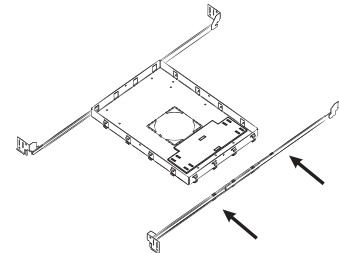

5. Adjust Hanger Bars

Adjust bars to match the spacing between the joists or T-bars. Then tighten adjustment screw to fix in place.

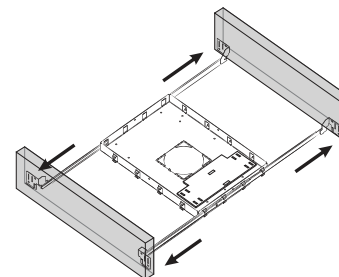

6. Fix to Structure

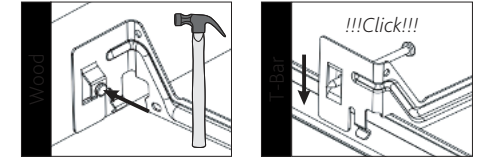

7. Cabling

Prepare power supply cables while easy access is present. Ensure there is enough excess cabling to allow connections to the junction/driver box.

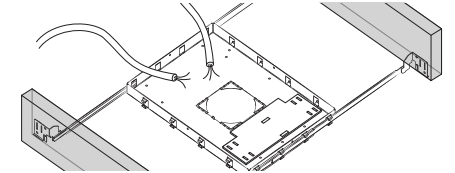

8. Junction/Driver Box

Connect mains and dimming (if specified) wires to the connectors within the junction box. Once done, fix junction box to non-IC tray with the 2x provided screws.

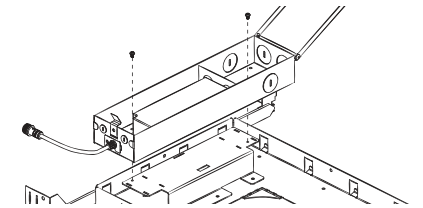

B = Black wire (L) from junction box
C = White wire (N) from junction box
D = Green wire / bare copper (G) from junction box
E = Black wire (L) from fixture
F = White wire (N) from fixture
G = Green wire / bare copper from fixture
H = Wire connectors x 3

9. Complete Drywalling

Create the correct cut-out for the product. Please observe MIN surface thickness (see step 2).

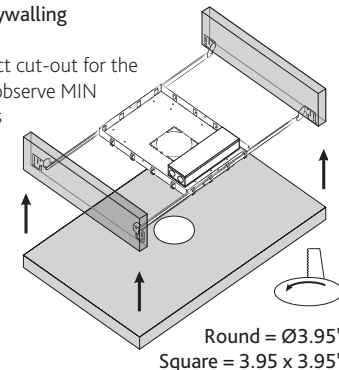

For further help regarding installation visit
lumino.lighting