

LUMINO

MATCH 3 M3-ST

INSTALLATION MANUAL

IMCE-M3-ST_R2301

TECHNICAL SUPPORT

+44(0) 1279 635 411
www.lumino.lighting

LUMINO DISTRIBUTION LTD

Lumino House, Lovet Road
Harlow, Essex CM19 5TB
United Kingdom

Authorised EU Representative:
LDL LIGHTING EUROPE LIMITED
The Black Church, St Mary's Place
Dublin, D07 P4AX
Ireland

Installers must read this document and any other referenced documents in full before commencing installation work.

Failure to observe all installation guidance in this document may result in unsafe installation, cause permanent product damage and void product warranty.

This document is subject to change without notice.
Check for latest documentation with LUMINO.
Copyright © LUMINO. E&OE



HANDLING PRECAUTIONS

GLASS / LENS

To avoid permanent damage, do not allow small or sharp objects to apply pressure on to the glass or lens.

STRESS

Never stand or place weighted items on the fitting.
The fitting is not vandal resistant and has no IK rating.
Do not subject the fitting to impact forces.

FIXING SURFACES

Check that surface is appropriate for the fitting being installed and can support its weight.

MODIFYING

Other than repair and replacement, this fitting must not be sawn, drilled or otherwise modified in any way.

DAMAGES

Inspect the product and accessories. If you see any damage upon unpacking, report to LUMINO immediately and do not install the product.

LOCATION

Fixed IP64 front / IP20 rear

Front is suitable for wet and damp locations.
Rear must be kept dry.

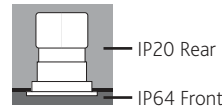

Adjustable IP20 front & rear

The entire product must be kept dry.

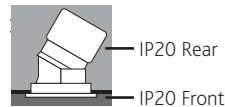

Fittings to be protected from dust, paint & harmful substances during installation and use. Do not expose to VOC's. Do not obstruct the fitting and its light output.

SAFETY GUIDANCE

WIRING GUIDE

Follow the guidance shown including maximum cable lengths, cable sizes and other wiring instructions.
When running cables through an enclosure, ensure cables are protected from damage, separated from mains voltage cables and anchored against being pulled.
Make connections appropriate for the installation and the IP rating of the product.

QUALIFIED INSTALLER & PRECAUTIONS

Installation must be carried out by a qualified person and conducted in accordance with local regulations and applicable standards. Use appropriate PPE and tools for the installation, as well as have a sufficient number of qualified personnel to carry out the work.

THERMAL MANAGEMENT

Ensure ambient temperature (Ta) does not exceed 25°C (77°F) and case temperature (Tc) does not exceed 85°C (185°F). Exceeding maximum Tc will cause permanent damage and void the product warranty. Allow sufficient clear air space for the LED drivers, as well as suitable access to the drivers as specified on installation instructions.

REPAIR AND REPLACEMENT

If the product is not functioning, contact LUMINO to register a Service Call for factory repair or replacement. Product's light source is replaceable by the manufacturer, their service agent or a similar qualified professional. See page 3 for Ecodesign and end of life information.

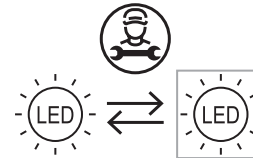

ACCESSORIES

CONSTANT CURRENT LED DRIVERS

DALI 2, 0.1% MIN dimming
- CC30-0300-L1D (300mA / 9W)
- CC30-0500-L1D (500mA / 16W)

1-10V, 0.1% MIN dimming
- CC30-0300-L1A (300mA / 9W)
- CC30-0500-L1A (500mA / 16W)

TRIAC, 20% MIN dimming
- CC30-0300-L1T (300mA / 9W)
- CC30-0500-L1T (500mA / 16W)

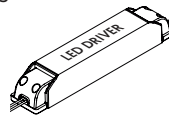

OPTIC FILTERS

Frosted soft focus filter
- SF

Honeycomb louvre
- HL

Solite Lens
- SO

Linear Spread Lens
- LS



DRIVERS

POWER OFF

Before work commences, the power supply must be off. Fitting and driver must not be live wired.

CONSTANT CURRENT DC LED DRIVER

Product is class III for Safety Extra Low Voltage (SELV). Supply current should not exceed 300mA (9W) or 500mA (16W), see product label for specified current. 1 x fitting per LED driver.

CHECK DIMMERS

Compatible with the driver and certified to local regulations.

INRUSH CURRENT

Many LED drivers can have high inrush current at power-on. Driver inrush current can be many times the normal operating current. Use a suitable MCB. Type C MCBs are normally suitable but if inrush current is a persistent problem an inrush suppressor may be required.

CABLING

Do not overload the driver. Damage will be caused by incorrect input voltage, reverse polarity or short circuit. Plan for loads, driver locations, dimming and cabling prior to start of work. Ensure basic insulation is maintained between mains and dimming control wires.

PROTECTION

Use only with constant current power supply with overload and short-circuit protection. Rate drivers for at least 10% above load. Driver protection circuitry must not be relied upon to protect secondary electrical circuits from damage caused by over-voltage or short circuit. DC fuses or DC electronic circuit breakers are recommended for full protection. Allow for access to drivers for maintenance and sufficient clear air space for ventilation.

FIRE HOOD

Thermal and acoustic, 120min flexible fire rated hood
Ø200mm x H200mm
- FAH200

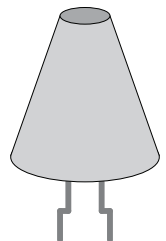

CHECK FIRST

TURN OFF POWER!
COUPER LE COURANT!
STROM ABSHALTEN!
CORTE CORRIENTE!

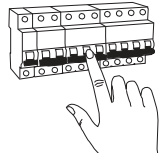

CHECK THE CEILING!
VÉRIFIER LE PLAFOND!
ÜBERPRÜFEN SIE DIE DECKE!
REVISE EL PANEL DE YESO!

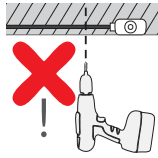

INSTALLATION

1. Plan Installation

Check the LED fitting and its dimensions.

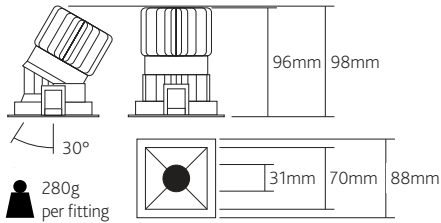

2. Ceiling Void Requirements

Allow space for the LED fitting to cool itself correctly.

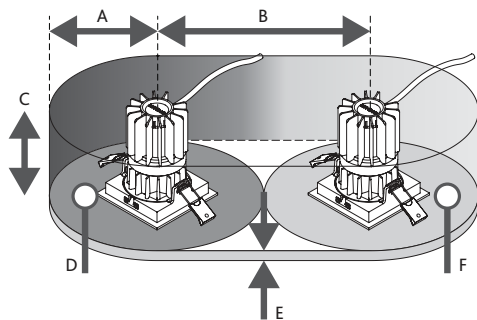

A = 90mm MIN from fitting to void edge
B = 180mm MIN between fittings
C = 125mm MIN height
D = 4 litres MIN air volume per fitting
E = 1-25mm surface thickness
F = Ceiling supporting 1.4kg MIN per fitting

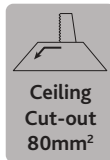

3. Fire / Acoustic Covers

Suitable for use with intumescent covers / acoustic hoods.
Allow an additional 10mm around all sides of the hood.

DO NOT
COVER WITH
INSULATION

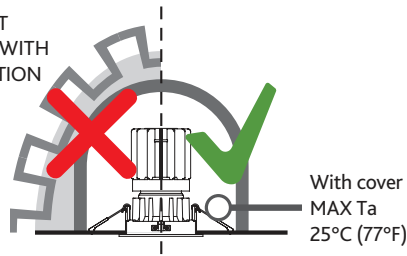

4. Install Bezel

Raise the bezel into the ceiling in a controlled manner.

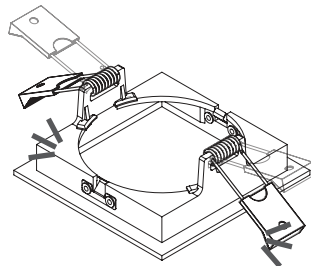
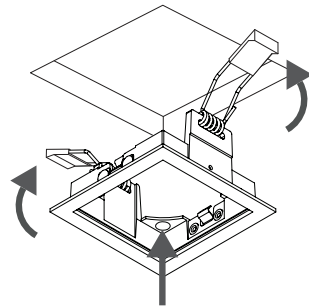

TAKE CARE! Spring hazard.



5. Power Supply Location and Cabling

Prepare primary and secondary cables and ensure the LED driver is in an accessible location.
MIN secondary conductor diameter: 0.5mm² / 22AWG
MAX secondary conductor diameter: 1.5mm² / 16AWG

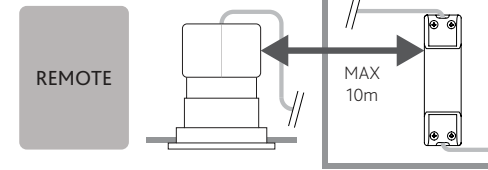
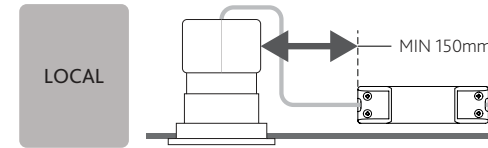

If the external flexible cable or cord of this luminaire is damaged, it shall be exclusively replaced by the manufacturer or service agent or a similar qualified person in order to avoid a hazard.

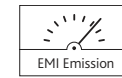

Ensure EMI emission do not exceed local regulated limits. Shield cables and ferrite coils can be used where applicable.

6. Connect Fitting to LED Driver

With the power off, join the fitting's cable to the LED driver. Use a connection appropriate for the installation and ensure that it is safe and secure.



DO NOT HOT WIRE!

7. Install Fitting

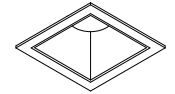
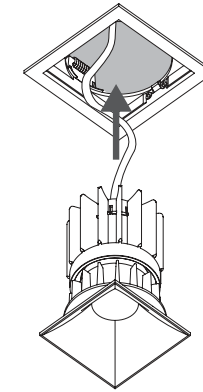

CHECK!
Fitting flush with bezel.

8. Adjustable / Wall Wash / Spreader Lens Option

Adjust the fitting according to the planned installation.

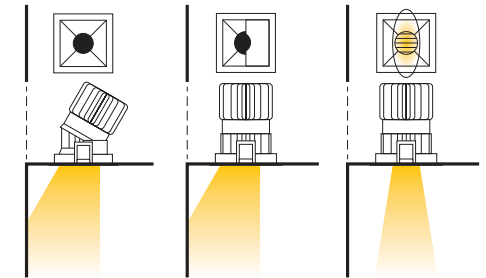

Adjustable

Wall Wash

Spreader Lens

9. Power On / Test

Validate functionality by powering on the fitting. If the fitting does not turn on, turn off the power immediately and check all connections before retesting.

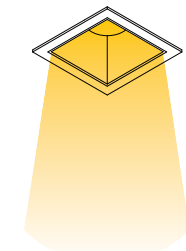

Ecodesign on following page...

REPAIR & REPLACEMENT

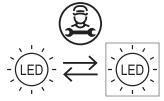

This product's light source is only replaceable by the manufacturer, their service agent or a similar qualified professional. **VERY IMPORTANT! PLEASE READ BEFORE CARRYING OUT ANY WORK!**

If the product has stopped working, please review the following before replacing the light source. It is important to identify why the product has stopped working first, as replacing the light source might not fix the cause of the failure.

When installed correctly, LEDs have a long service life, with light output gradually decreasing over time.

Check the lighting circuit.

Was the correct power sourced used? Check product label for requirements.

Are there nearby heat sources that might overheat the product? See first page for maximum Ta and Tc details.

All work must be done by a qualified professional, and carried out in accordance with local regulations. All tools required to replace the light source are commonly found tools. Please contact LUMINO if further assistance is required.

It is the full responsibility of the professional carrying out the repair work to ensure that after the work is complete, the repaired product still complies with all relevant safety standards and is safe to use. LUMINO cannot accept liability for any harm resulting from an unsafe repair. If in any doubt, do not carry out repair work and contact LUMINO for support.

TOOLS & PARTS LIST

Tools & Consumables Required

- Philips screwdriver
- Soldering iron
- Lead-free solder
- Isopropyl alcohol (solution / wipes)
- Long-life, non-conductive thermal paste, thermal conductivity >8W/mK.
- Ø30mm / Ø1in Suction cup with pull handle to remove fitting
- (Optional) Gloves
- (Optional) Pry tools
- (Optional) Tweezers
- (Optional) Grippy rubber matt

Spare Parts

The following spare parts are available to order. Please contact LUMINO if any spare parts are required.

- **LEDs** - Please contact LUMINO for a direct replacement LEDs. For equivalent LEDs see page 5.
- **Optics** - 25° Narrow / 35° Medium / 45° Wide / 55° Extra wide
- **Additional Hardware** - COB holder / Screws / Cable (Ø3.9mm, 2-core, 0.5mm², PVC+PEP)

IMCE-M3-ST_R2301

INSTRUCTIONS

1. Turn off the power.

Make sure no electricity can reach the LED power supply.

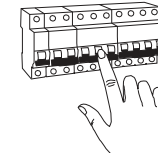

2. Check Product Label

Remove from ceiling. See product label and check specification of LED inside. Replacement power requirements should match or be no greater than that of the original LED.

3. Remove and Disconnect LED downlight.

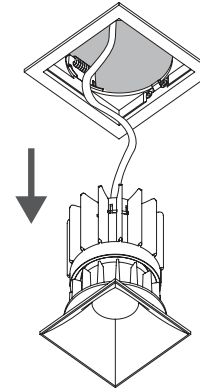

4. Move the Product

Move the LED fitting to an ESD safe workspace. Use ESD precautions to protect the LED.



5. Remove Front

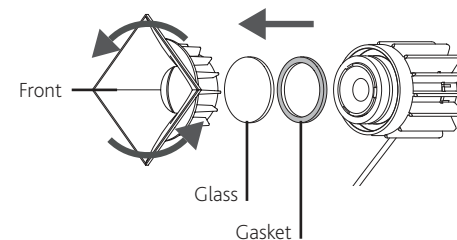

Page 3

6. Remove Optic

If the optic is difficult to release, rest the optic flat against a grippy rubber/silicone matt and twist.

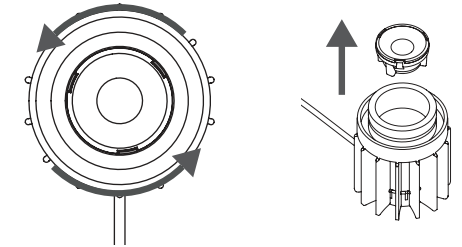

7. Remove Screws & COB Holder

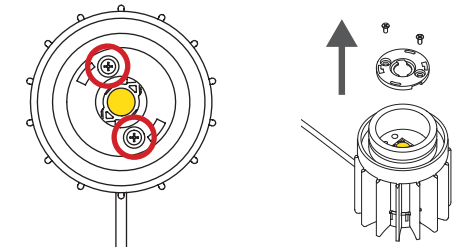

8. Unsolder COB LED

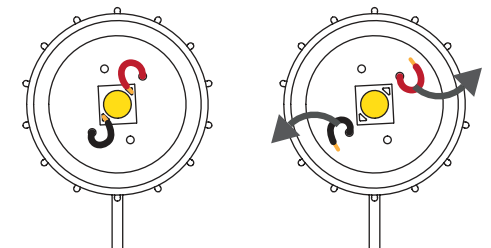

9. Remove COB LED

Remove COB LED from heatsink. Use tweezers or pry tools to aid with removal if LED with stuck down.

For further help regarding installation visit lumino.lighting

10. Recycling

Dispose of electronic waste in accordance with local environmental regulations. Do not send to landfill!



11. Clean Heatsink

Use isopropyl alcohol (solution/wipes) to clean heatsink.

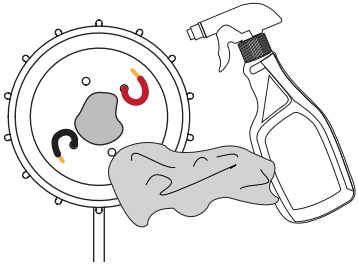

IMPORTANT! Handling the LED (COB)

Correct handling of the LED is important to ensure the longevity and reliability of the LED. Natural oils from skin contact can damage the lit surface of the LED. Use gloves or tweezers to hold the LED. Do not touch or apply any pressure to the centre, as shown in red. Outer edges shown in green are safe to touch.

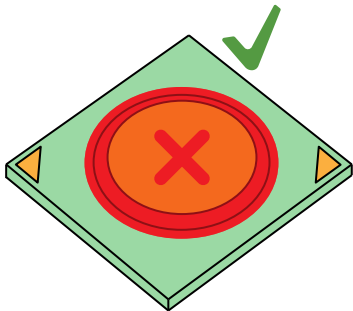

The LED is covered in a soft silicone, pressure applied to this silicone will cause damage to the LED.

Inspect LED prior to installation. Check for any signs of damage such as cracks, chips, dark spots or deformation. Do not attempt to repair a damaged LED, contact LUMINO for assistance.

IMCE-M3-ST_R2301

12. Apply Thermal Paste

Paste amount should be small, the size of a grain of rice.

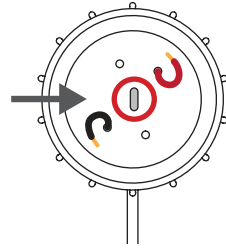

13. Solder Contacts on LED (COB)

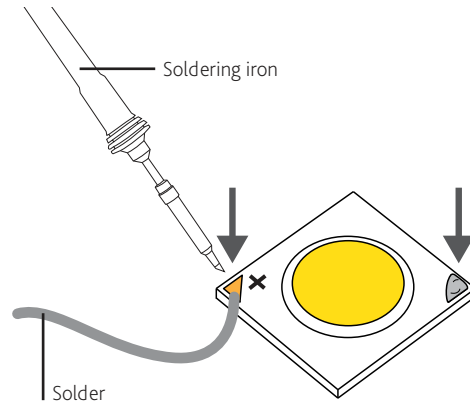

14. Solder Wires to LED

Orientate the LED so that the contact pads match with the corresponding wires on the heatsink, align as shown. Centre and set down the LED. Solder wires to LED.

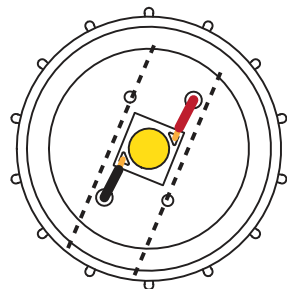

15. Fasten Down LED & Optic Holders

IMPORTANT! Screws must be touch tight, 0.3nm MAX. Over tightening will break the LED.

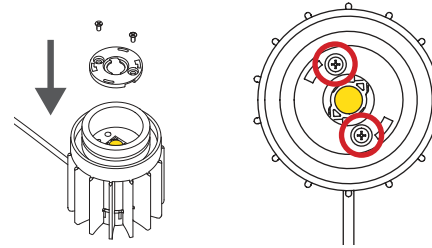

16. Install Optic

Twist and lock into place.

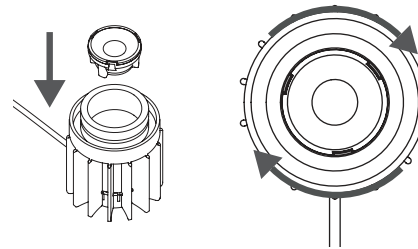

17. Install Front

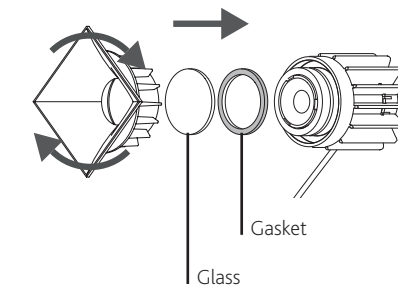

18. Reconnect and Install LED fitting.

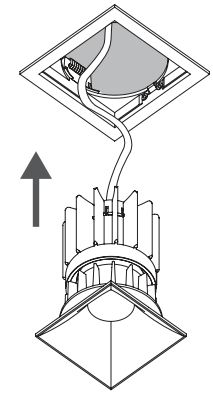

19. Power On / Test

Validate functionality by powering on the LED. If the LED does not turn on, turn off the power immediately and check all connections before retesting.

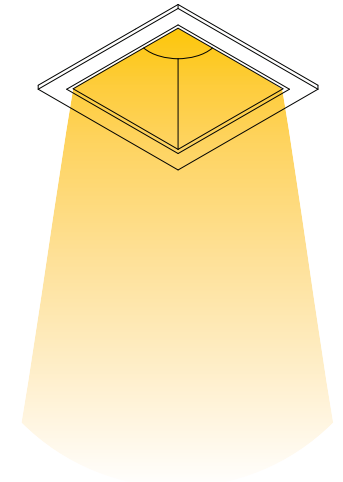

LUMINO

ECODESIGN REGULATION

This product is considered to be a “containing product” in the sense of Regulations (EU) 2019/2020 and (EU) 2019/2015.

The light source contained in this luminaire shall only be replaced by the manufacturer, their service agent or a similar qualified professional.

This product contains a light source of energy efficiency class as shown in the Energy Rating table. Replacement light sources must be of equal or higher energy rating. Full electrical, mechanical, thermal and optical functionality must be restored when light source is replaced.

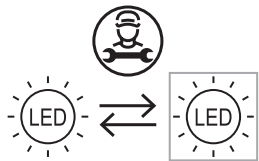

DISMANTLING

Dismantling of light source from the containing product at end of life:

The product shall be disassembled in accordance to the provided instructions.

Containing products shall be separated from building material and/or from other additional mounting accessories by means of a professional installer.

Separate control gear and light sources must be disposed of at certified disposal companies in accordance with Directive 2012/19/EU (WEEE) in the EU and with Waste Electrical and Electronic Equipment (WEEE) Regulations 2013 in the UK.

LUMINO is a member of the WEEE producer compliance scheme.
Registration number: WEE/MM8138AA

ENERGY RATING

This product contains light sources of energy efficiency classes as shown:

LED	CCT	EPREL	Energy Class
eCORE	4000K	1168472	E
	3500K	1168465	E
	3000K	878975	E
	2700K	1168453	E

EQUIVALENT LEDs

This product's light source can be replaced by an equivalent light source from another brand, providing it matches or betters the specifications of the original light source (operating wattage must not exceed original specification).

Basic parameters to meet:
13.5mm², Ø10mm LES, 36V COB LED, CCT and power output should match original specification, 90CRI R9 = >50.